

KEY PRINCIPLES FOR SHELTER CONSTRUCTION IN THE SOLOMON ISLANDS

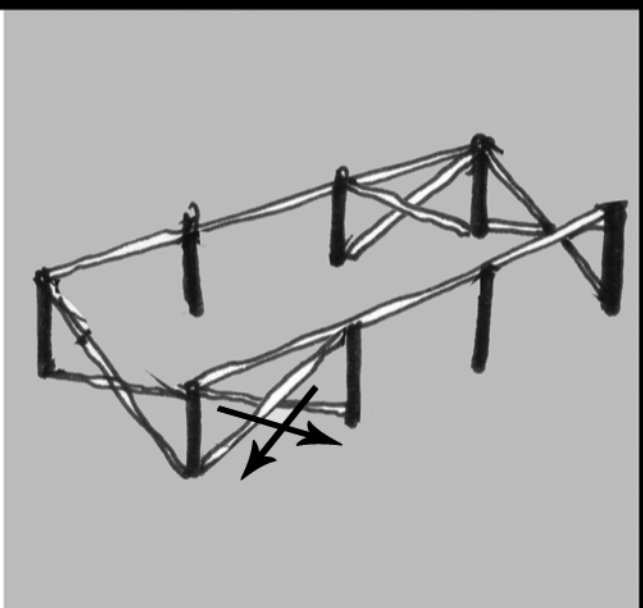
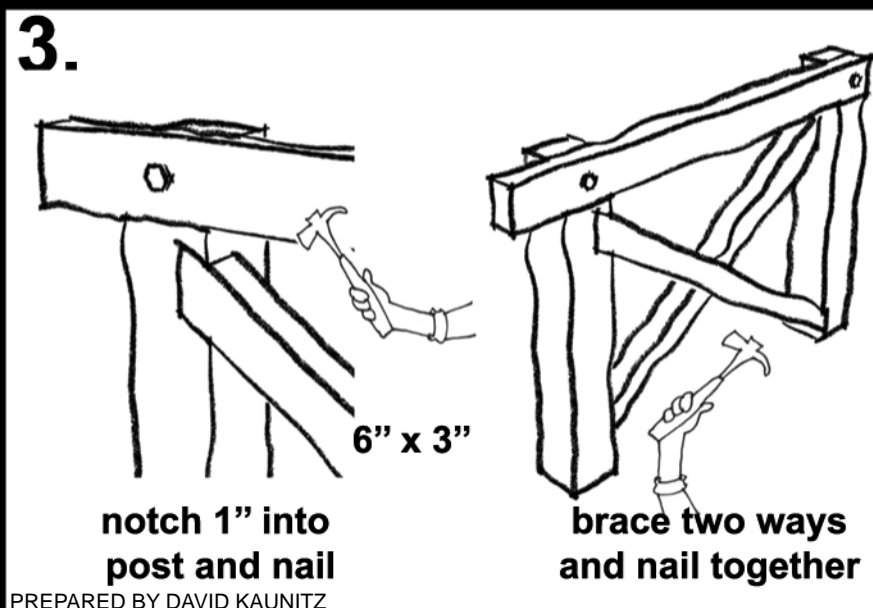
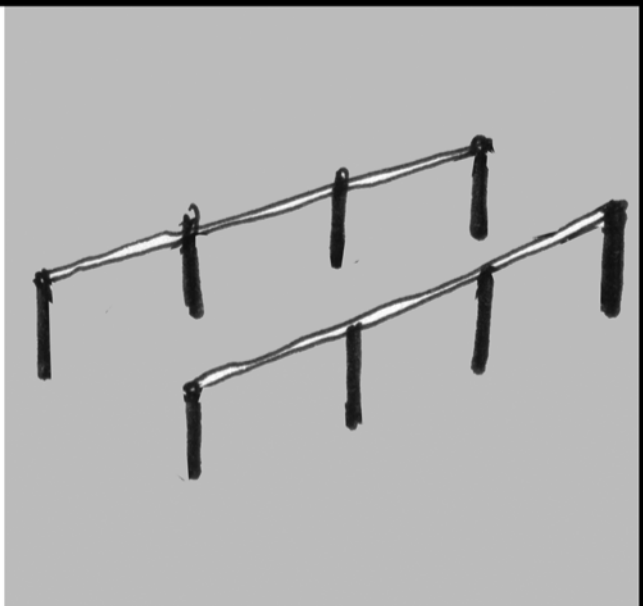
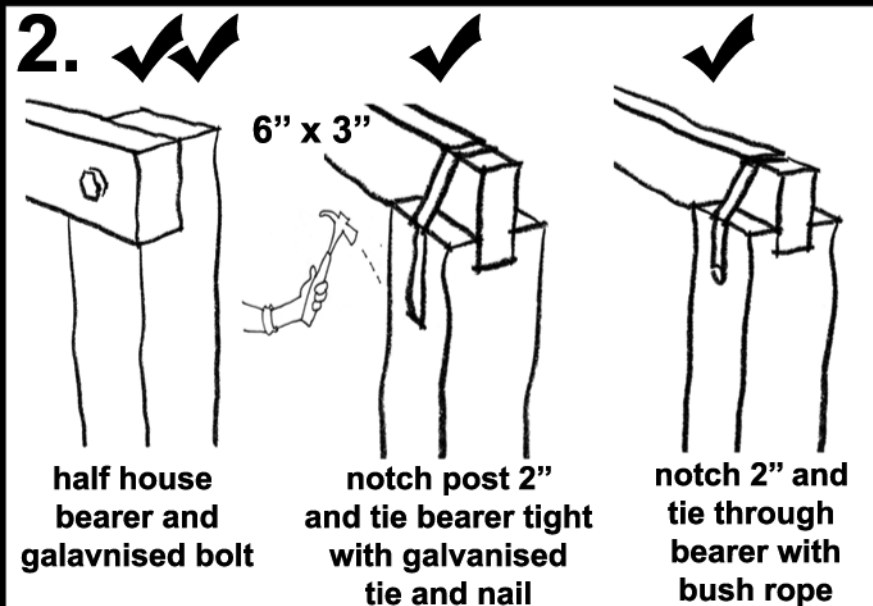
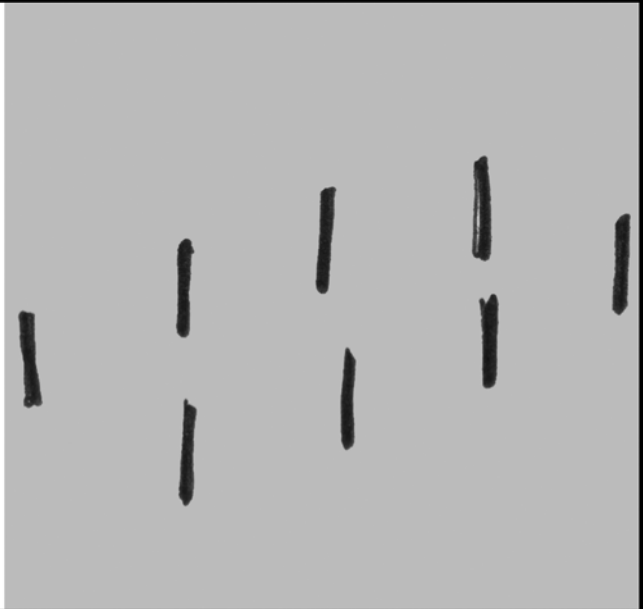
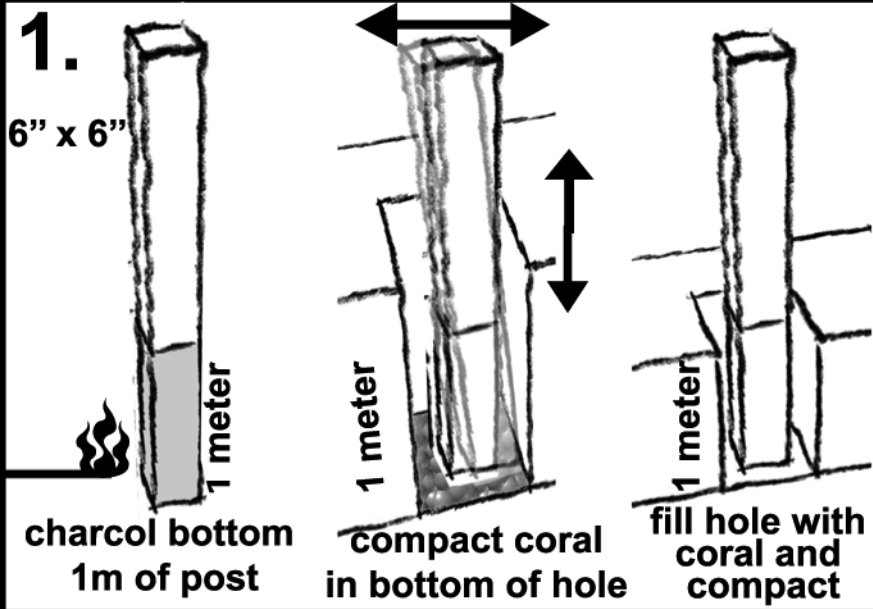

PREPARED BY DAVID KAUNITZ

- note:**
- avoid deep notches that compromise timber strength
 - ensure all bracing is in the same plane as structure
 - all fixings to be galvanised
 - metal roof sheeting is not recommended

4. ✓✓



tie stud to post with bolts

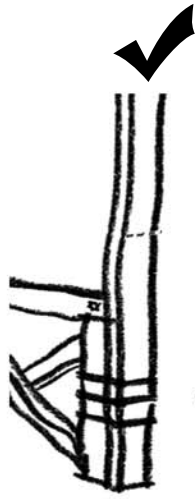

tie stud to post with galvanised strap or bush rope

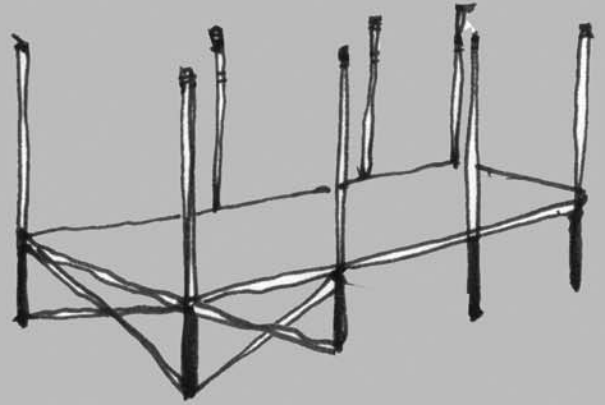

5.

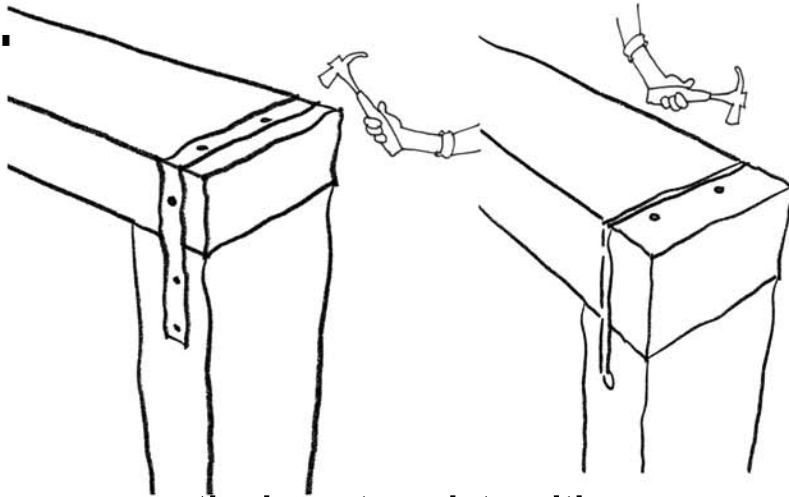

tie down top plate with galvanised strip or bush rope

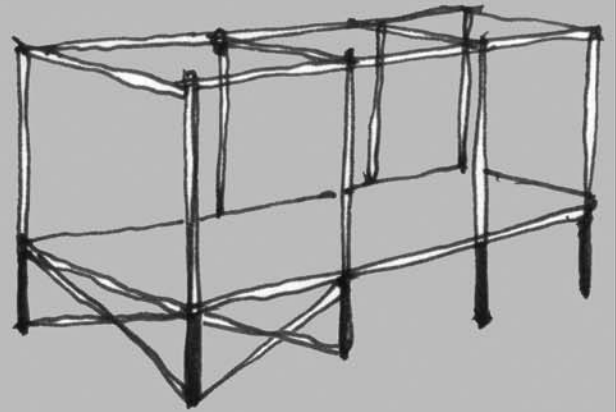

6.

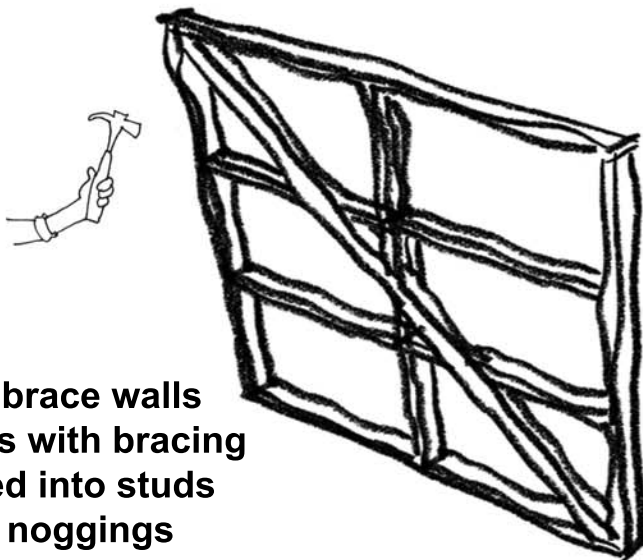

cross brace walls and roofs with bracing checked into studs and noggings

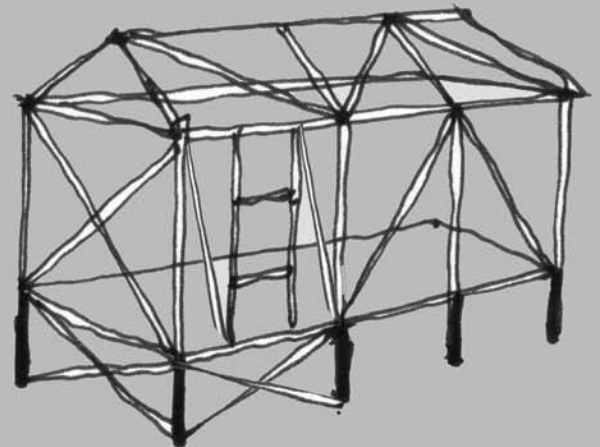

PREPARED BY DAVID KAUNITZ

- note:**
- avoid deep notches that compromise timber strength
 - ensure all bracing is in the same plane as structure
 - all fixings to be galvanised
 - metal roof sheeting is not recommended